

Row Configurations

Module Lengths

Verge™ wall systems are available in nominal 4ft and 8ft modules. Exact overall module lengths are shown to the right (without endcaps).

Indicates overall nominal length of module. Module lengths do not include endcaps. Endcap dimensions are shown below.

T5/T5HO lamp versions

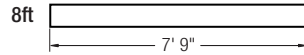
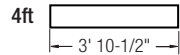

T8 lamp versions

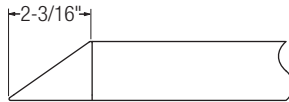
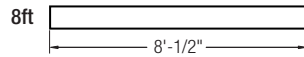
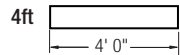

Endcaps

Overall row lengths do not include endcaps. Add two endcaps to the overall length of each row.

Mount Spacing

- Variable wall mount brackets can be positioned within 2"-4" of fixture end or joint.
- Maximum distance between mounts is 48"

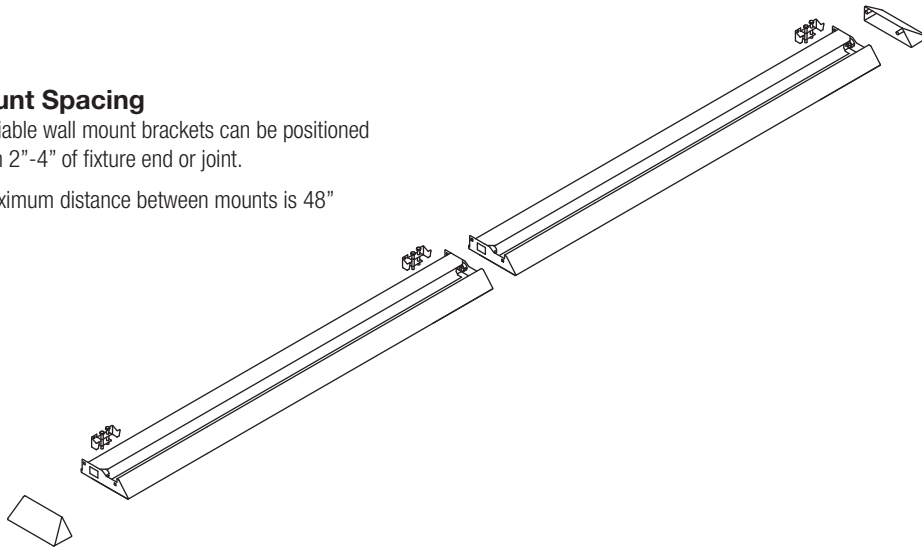

Row Configurations

The tables below indicate how nominal 4ft and 8ft modules can be combined to create continuous rows of various lengths. Modules can be combined in any order.

Note: T5/T5HO and T8 lamp versions are different lengths. See Table A for T5/T5HO versions and Table B for T8 lamp versions.

Table A: T5/T5HO lamp versions

Nominal Row Length	Number of Modules Required		Installed Row Length (not including endcaps)
	4'	8'	
4'	1x		3' 10-1/2"
8'		1x	7' 9"
12'	1x	1x	11' 7-1/2"
16'		2x	15' 6"
20'	1x	2x	19' 4-1/2"
24'		3x	23' 3"
28'	1x	3x	27' 1-1/2"
32'		4x	31' 0"
36'	1x	4x	34' 10-1/2"
40'		5x	38' 9"
44'	1x	5x	42' 7-1/2"
48'		6x	46' 6"
52'	1x	6x	50' 4-1/2"
56'		7x	54' 3"
60'	1x	7x	58' 1-1/2"
64'		8x	62' 0"
68'	1x	8x	65' 10-1/2"
72'		9x	69' 9"
76'	1x	9x	73' 7-1/2"
80'		10x	77' 6"
84'	1x	10x	81' 4-1/2"
88'		11x	85' 3"

Table B: T8 lamp versions

Nominal Row Length	Number of Modules Required		Installed Row Length (not including endcaps)
	4'	8'	
4'	1x		4' 0"
8'		1x	8'-1/2"
12'	1x	1x	12'-1/2"
16'		2x	16' 1"
20'	1x	2x	20' 1"
24'		3x	24' 1-1/2"
28'	1x	3x	28' 1-1/2"
32'		4x	32' 2"
36'	1x	4x	36' 2"
40'		5x	40' 2-1/2"
44'	1x	5x	44' 2-1/2"
48'		6x	48' 3"
52'	1x	6x	52' 3"
56'		7x	56' 3-1/2"
60'	1x	7x	60' 3-1/2"
64'		8x	64' 4"
68'	1x	8x	68' 4"
72'		9x	72' 4-1/2"
76'	1x	9x	76' 4-1/2"
80'		10x	80' 5"
84'	1x	10x	84' 5"
88'		11x	88' 5-1/2"

! ATTENTION: Install in accordance with national and local building and electrical codes. Page 1

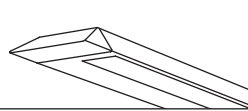

Power Feed

Power for the entire row can be placed at either end or any joint. *See examples below.*

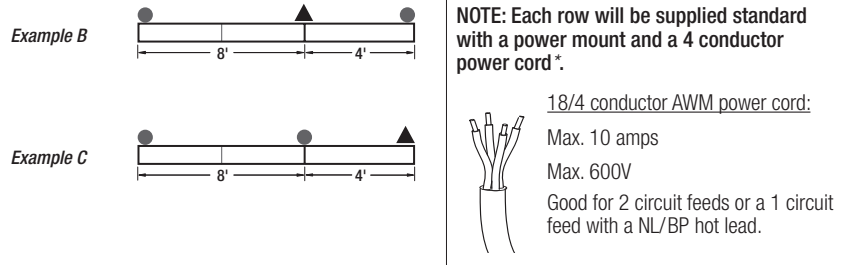
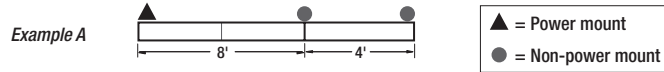

Emergency Circuit (EM), Night Light (NL) or Battery Pack (BP) Option

Modules are available with optional EM/NL circuit or BP. EM/NL/BP each power one 4ft end section of a module. EM/NL/BP sections will always be installed on the right side (when facing wall).

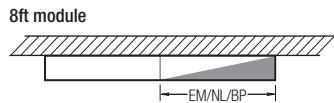
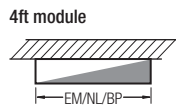

Emergency Circuit (EM), Night Light (NL) and Battery Pack (BP) placement in rows

Placement of EM/NL/BP modules is variable throughout a row. *See examples below of EM/NL/BP installed in 20ft rows.*

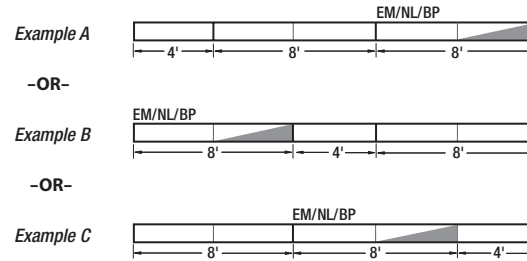

IMPORTANT: Whenever longer rows are made up of both 4' and 8' modules, EM/NL/BP sections will always be installed in 8' modules. If specific site restrictions require EM/NL/BP sections to be installed in 4' sections, please contact the factory.

Power feeds for rows installed with Night Light (NL) or Battery Pack (BP)

Every NL/BP module will be supplied with an additional 4 conductor power cord and power mount to enable variable power locations, as shown in the examples below.

For NL and BP installation, power can be installed adjacent to normal power or in a separate location.

See examples A and B below.

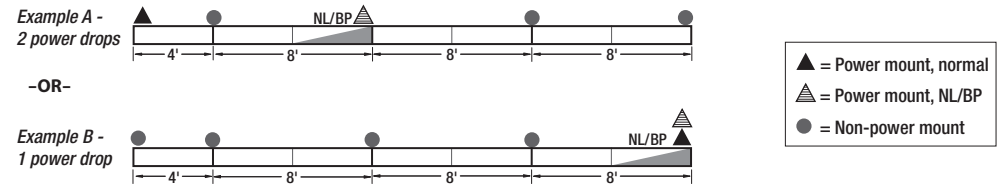

Power feeds for rows installed with Emergency Circuit (EM)

Every EM module will be supplied with an additional 4 conductor power cord and power mount to enable variable power locations, as shown in the examples below.

For EM installation, in all instances, code restrictions require two separate power drops, one for normal power and one for EM power. EM power must be installed in a location different than the normal power. *See example A below.*

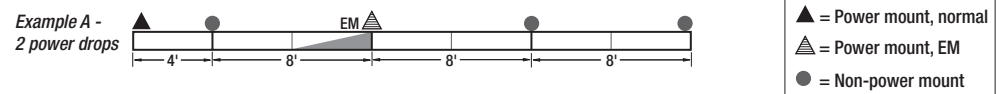

! ATTENTION: Install in accordance with national and local building and electrical codes. **Page 2**